

# NARIKKA- JA PALVELUTILOJEN KALUSTEET

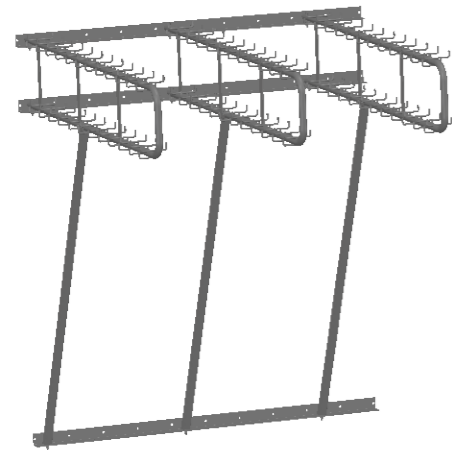

NP1

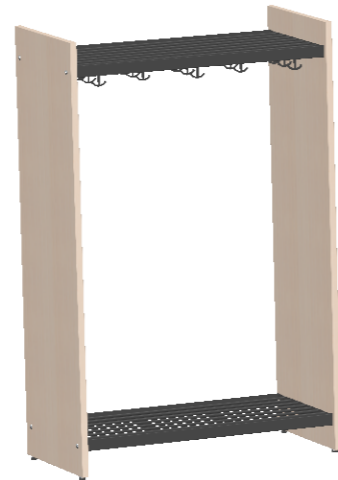

A KLT1

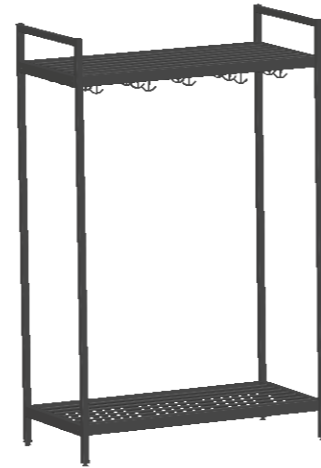

A KLT6

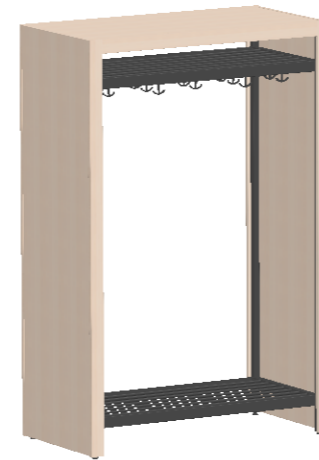

A KLT8

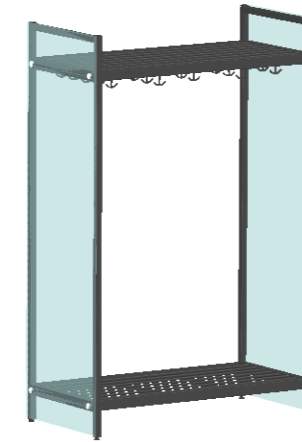

A KLT9



NP2

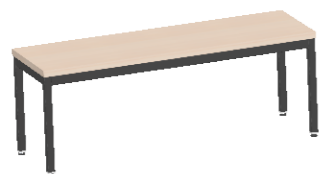

A PE1

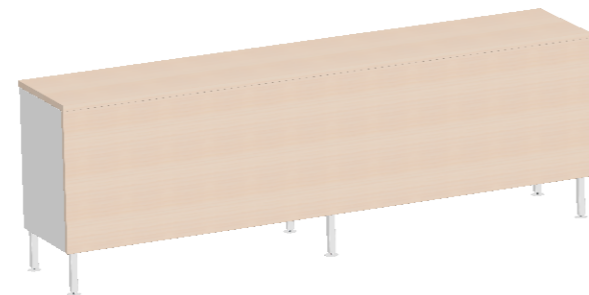

NP3



NP4



NP5



NP6

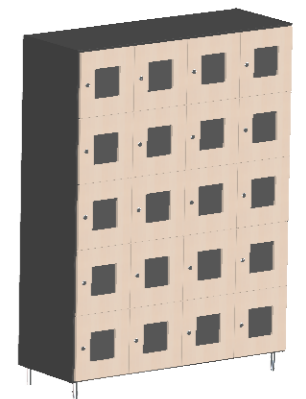

NP7

					Customer Mallilat												
			General Tolerance		Description Narikka- ja palvelutilojen kalustemoduulit												
<table border="1"> <thead> <tr> <th>Name</th> <th>Date</th> <th>Material</th> </tr> </thead> <tbody> <tr> <td>Designed By</td> <td>4.4.2023</td> <td></td> </tr> <tr> <td>Approved By</td> <td></td> <td>Mass 877.44 kg</td> </tr> <tr> <td></td> <td></td> <td>Dimensions (mm)</td> </tr> </tbody> </table>			Name	Date	Material	Designed By	4.4.2023		Approved By		Mass 877.44 kg			Dimensions (mm)	Document Number <b>104353</b>		Size <b>A3</b>
Name	Date	Material															
Designed By	4.4.2023																
Approved By		Mass 877.44 kg															
		Dimensions (mm)															
			Color		Rev												
Revision			Description		Designer												
			Date		Date												
			Scale 1:100		Sheet 4 / 4												

This document must not be copied without our written permission, and the contents thereof must not be imparted to a third party nor be used for any unauthorized purpose. Contravention will be prosecuted.

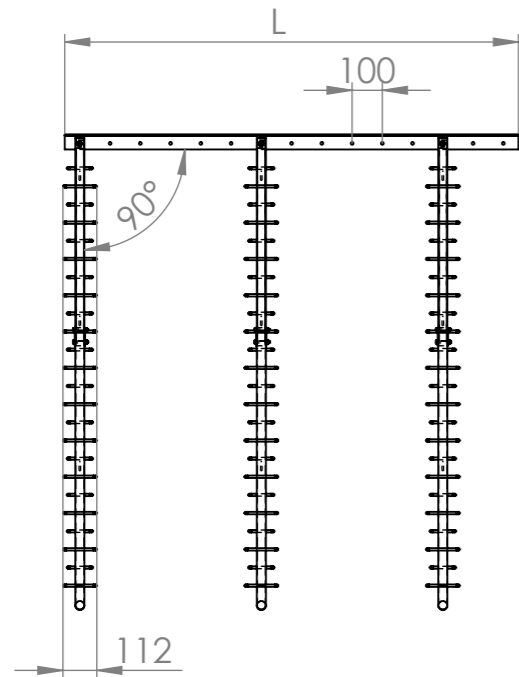
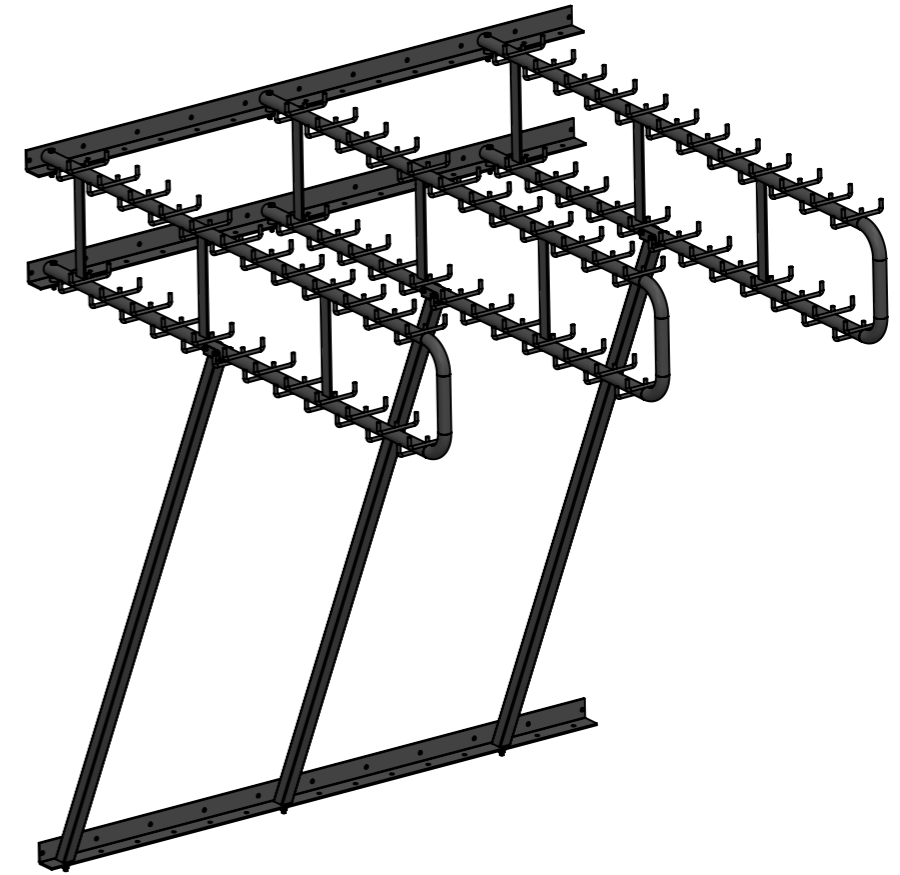
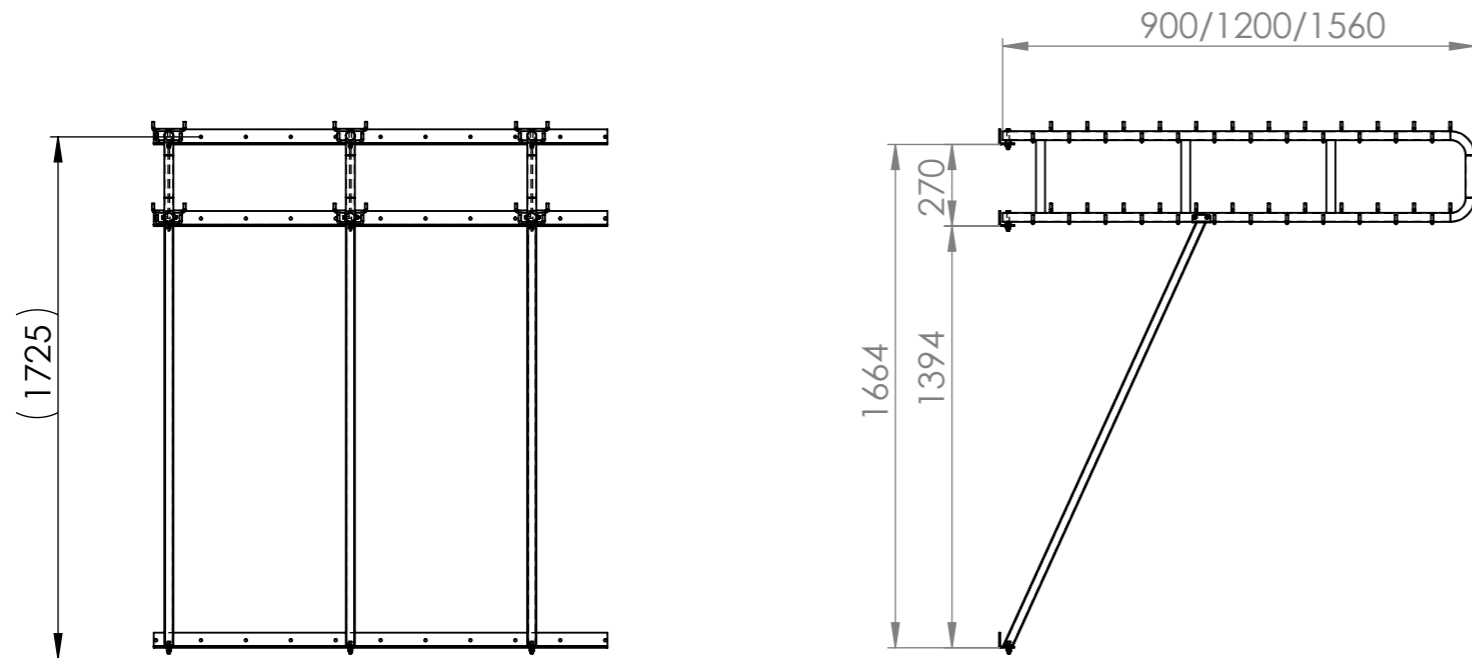

SEINÄKISKOT ASENNETAAN SEINÄÄN SEINÄRAKENTEEN VAATIMILLA KIINNITYSOSILLA.  
TARVITTAESSA SEINÄKISKOJA LYHENNETÄÄN MÄÄRÄMITTAAN.

SEINÄNAULAKON AISOJA JA VINOTUKIA ASENNETAAN SEINÄKISKOIHIN HALUTTU MÄÄRÄ.

					Customer Mallitilat	
			Description Orsi 1616 kääntönaulakko			
Designed By 			Date 27.3.2023		Document Number <b>NP1</b>	Size A3
Approved By 			Mass 40.63 kg			Color
Dimensions (mm)			Scale 1:25		Sheet 1 / 1	

Revision	Description	Designer	Date
----------	-------------	----------	------

130/151/185

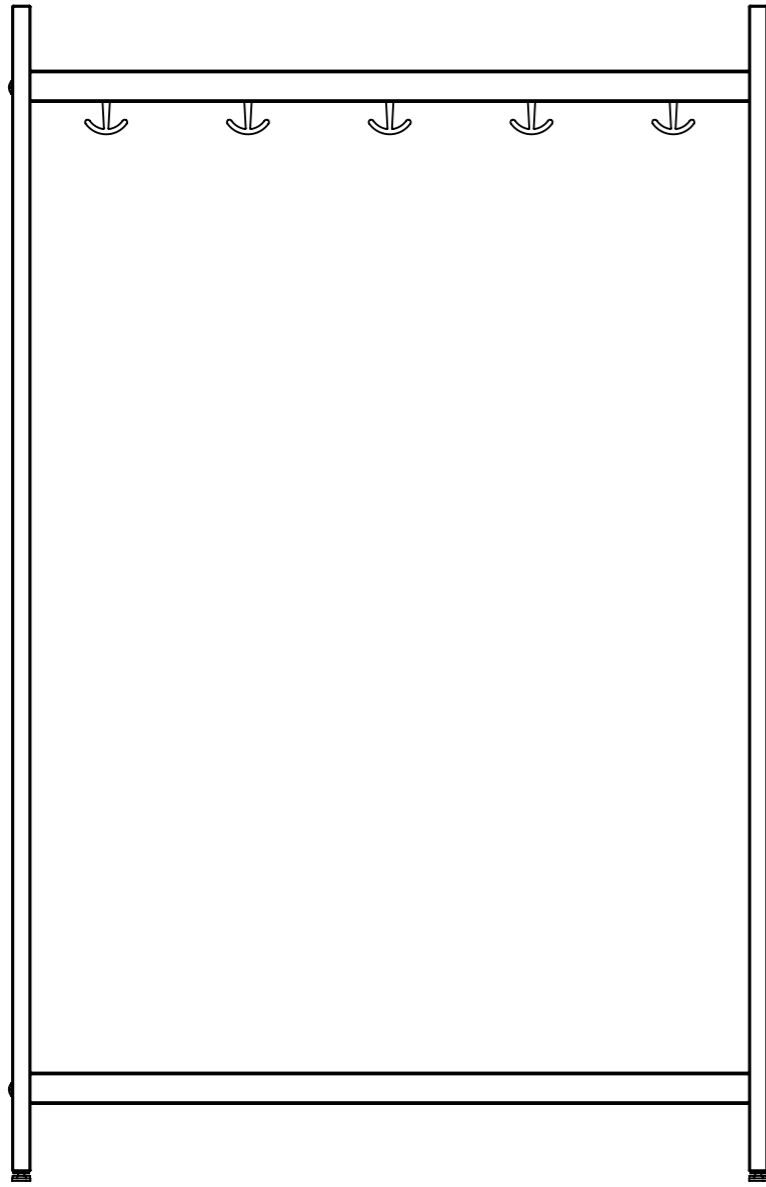

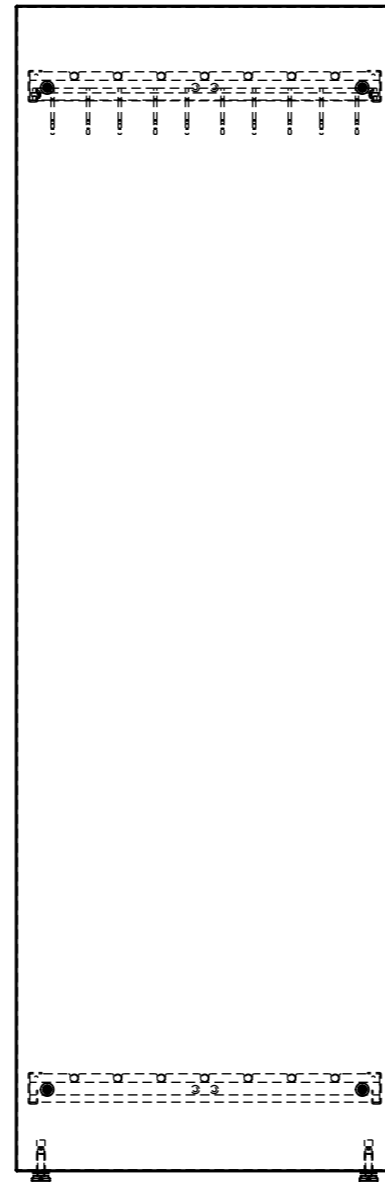

80/100/120

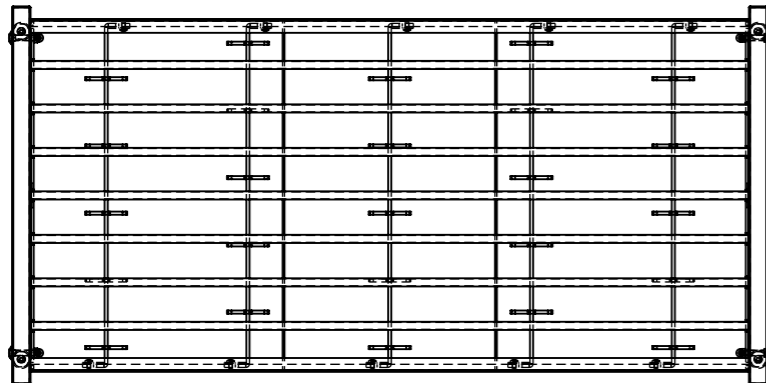
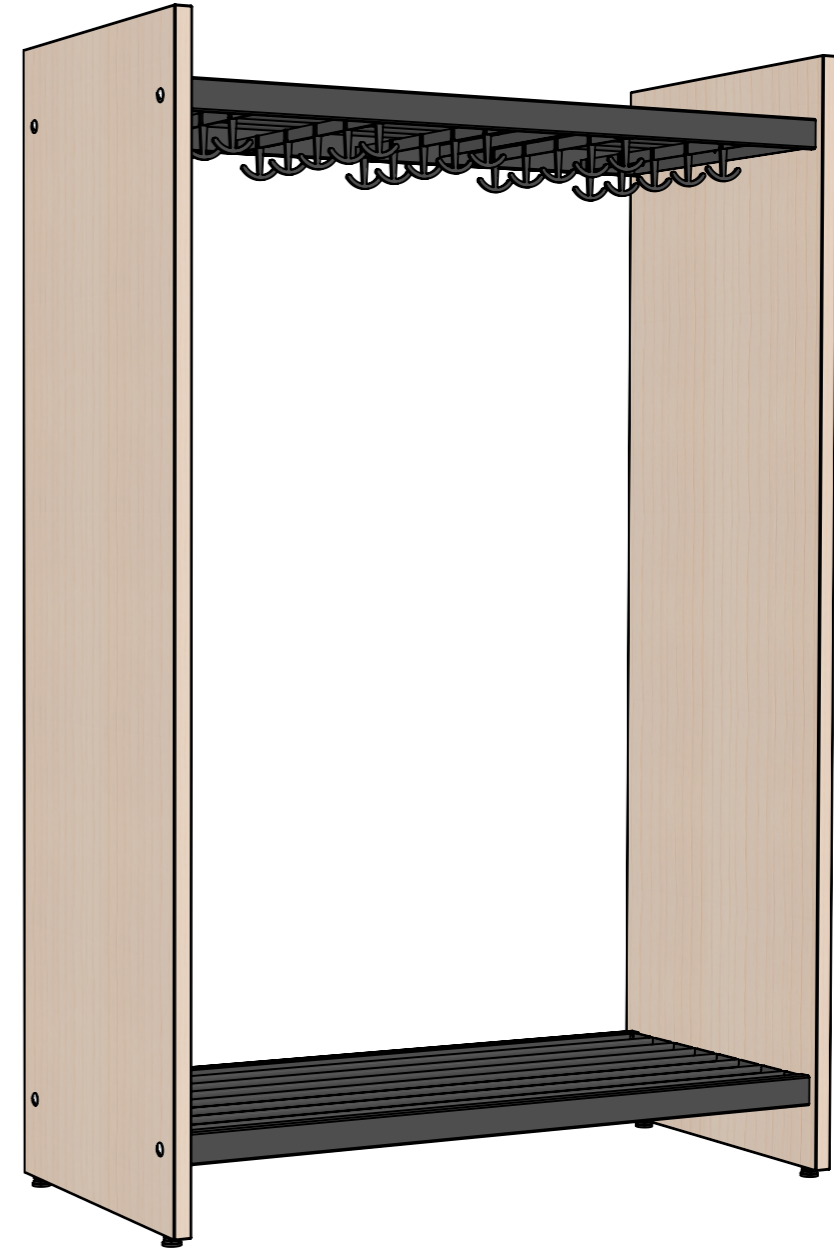

60



					Customer Mallilat	
			Description Massive 2004 naulakko			
Designed By JT <i>i</i>			Date 24.11.2022		Document Number <b>A KLT1</b>	Size A3
Approved By			Mass 83.69 kg			Color
Dimensions (mm)			Scale 1:12		Sheet 1 / 1	

Revision	Description	Designer	Date
----------	-------------	----------	------

This document must not be copied without our written permission, and the contents thereof must not be imparted to a third party nor be used for any unauthorized purpose. Contravention will be prosecuted.

185

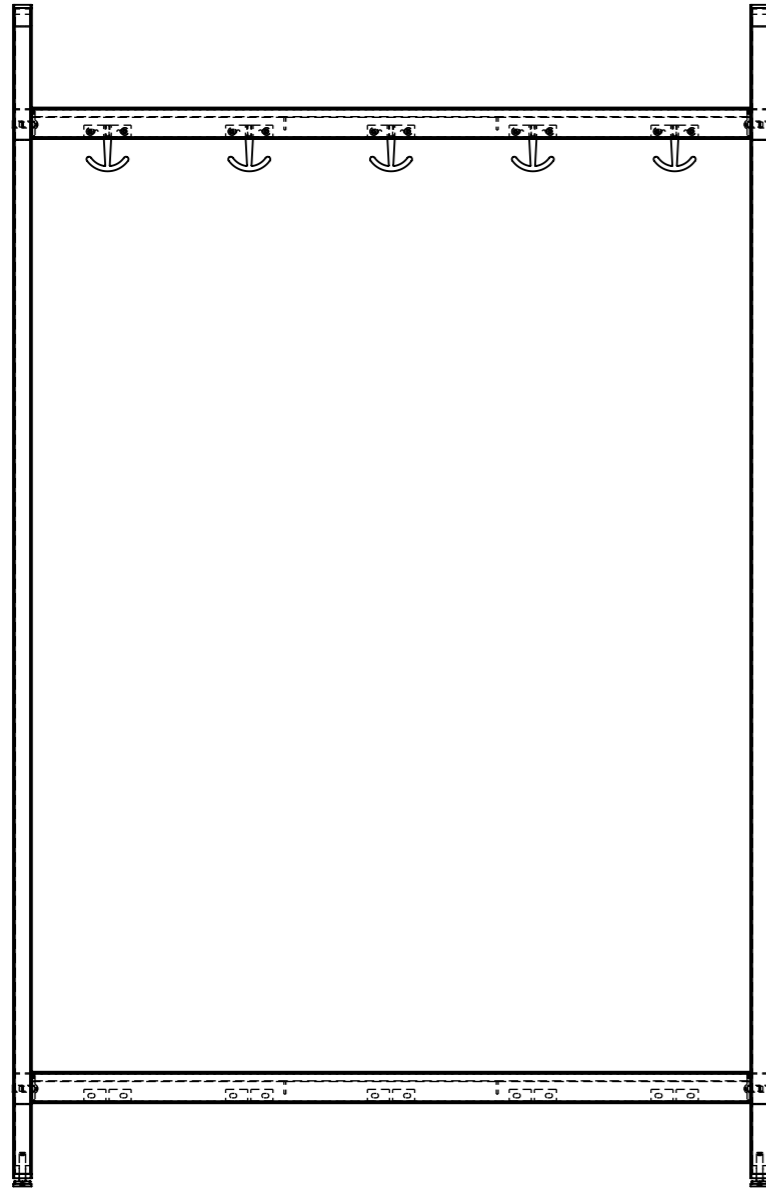

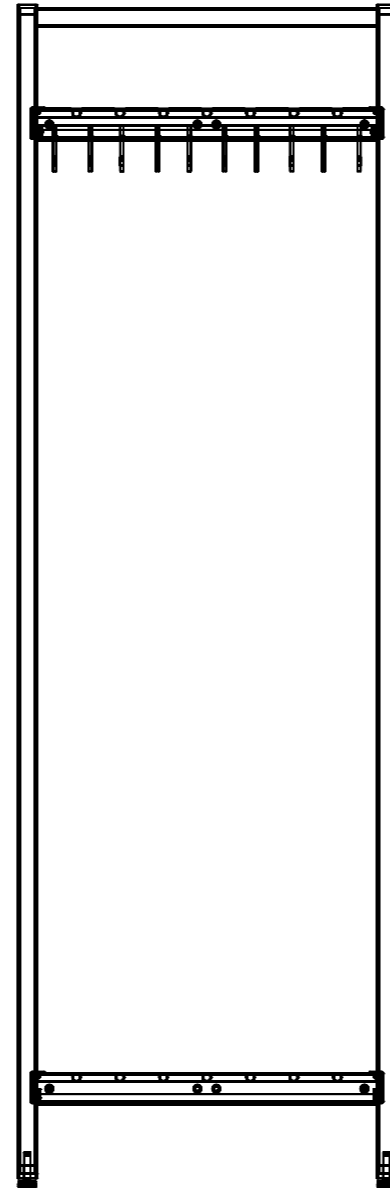

80/100/120

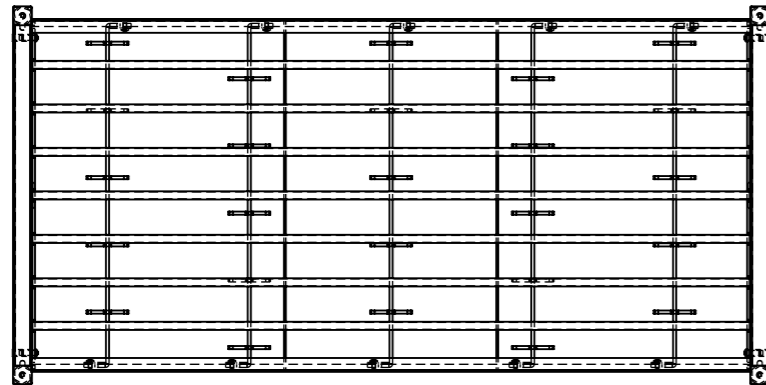
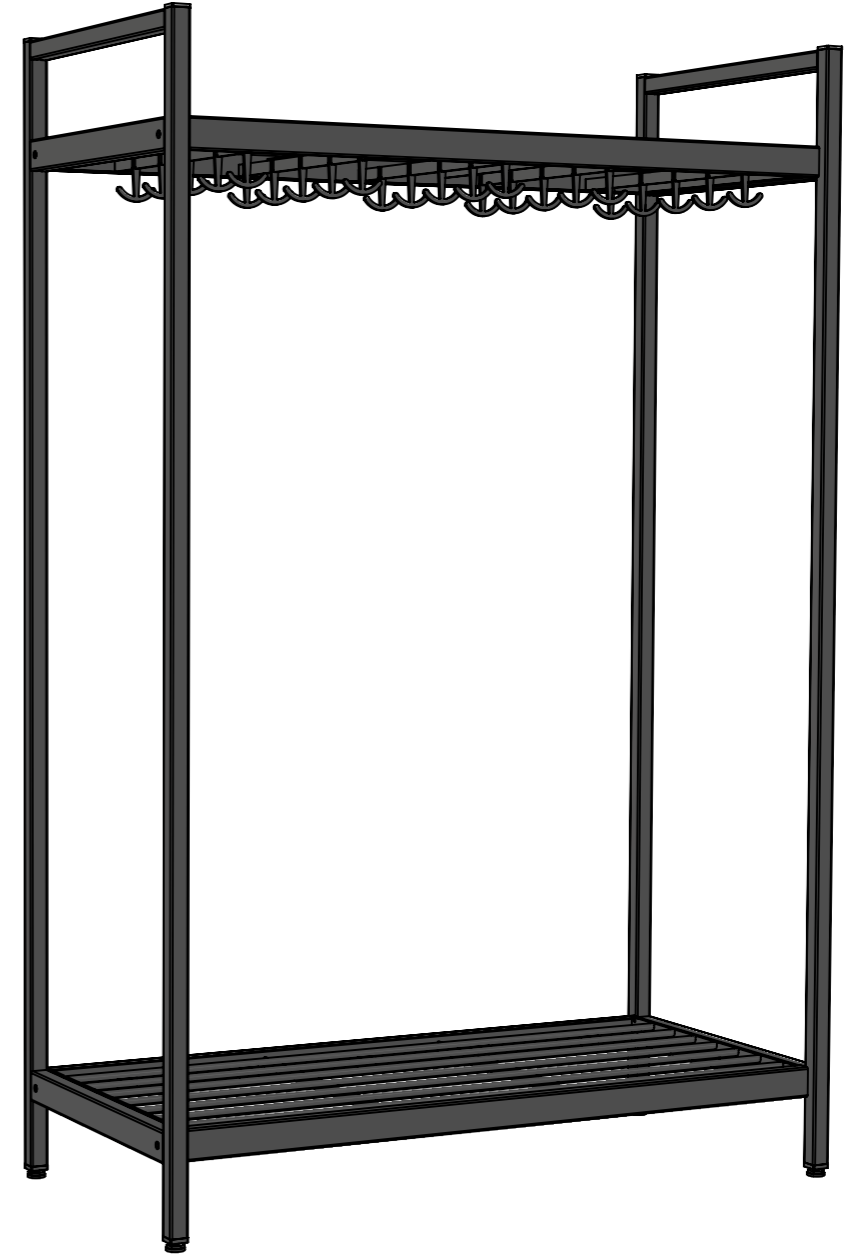

60



					Customer	Mallitilat
			Description		Quadrat 1804 naulakko	
Designed By			Date		Document Number	
Approved By			Material		A KLT6	
Revision			Mass		Color	
Description			Dimensions (mm)		Scale 1:12	
Designer			Date		Sheet 1 / 1	
					Size A3	
					Rev	

This document must not be copied without our written permission, and the contents thereof must not be imparted to a third party nor be used for any unauthorized purpose. Contravention will be prosecuted.

187

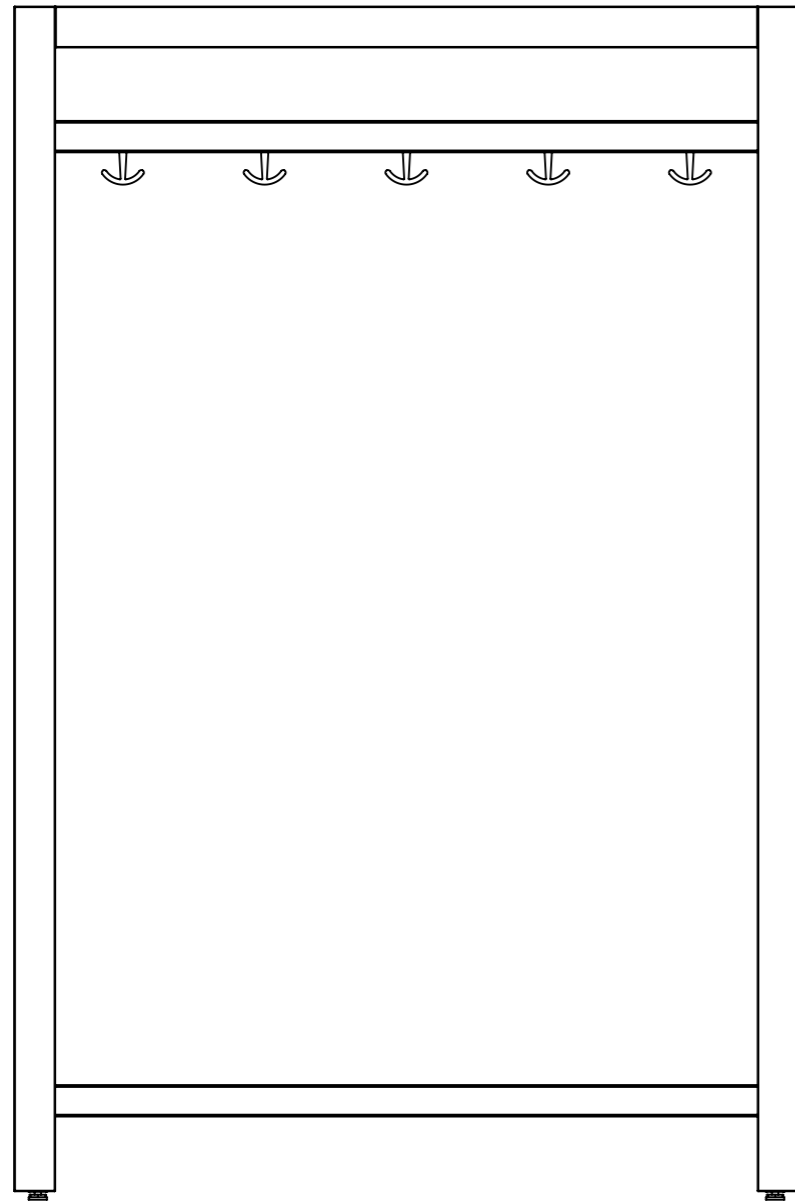

84/104/124

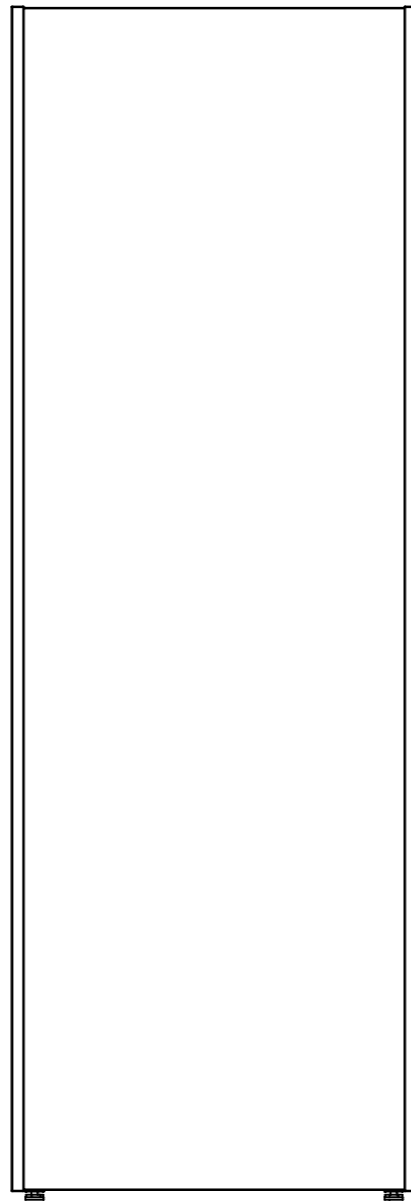

64

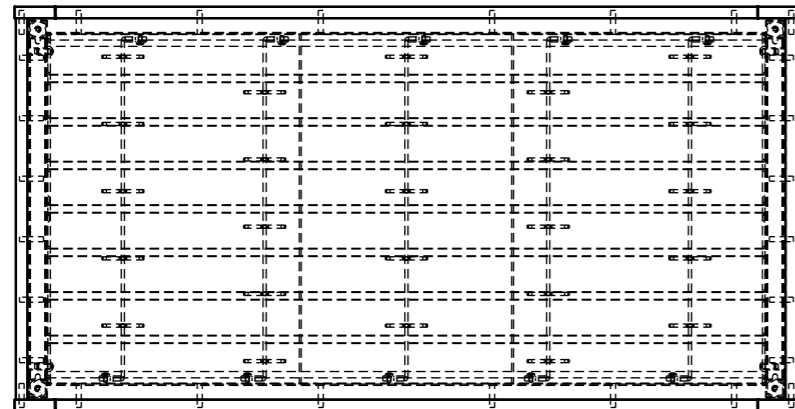
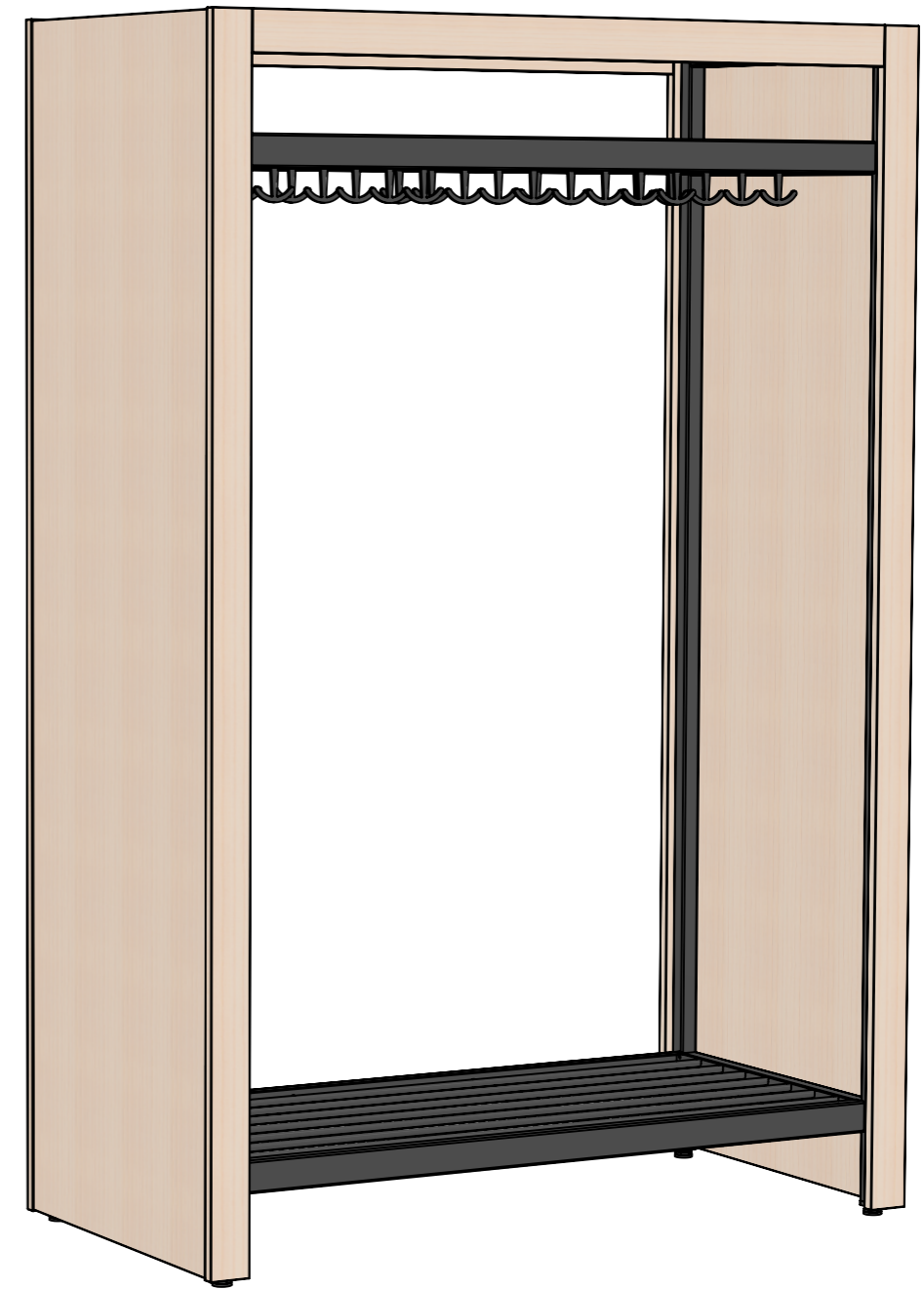

					Customer Mallilat
			Description Quadrat 1804 naulakko puukotelolla		
Designed By JT <i>i</i>			Date 24.11.2022		Document Number A KLT8
Approved By			Mass 103.43 kg		Color
Dimensions (mm)			Scale 1:12		Sheet 1 / 1
Size A3					Rev

Revision	Description	Designer	Date
----------	-------------	----------	------

This document must not be copied without our written permission, and the contents thereof must not be imparted to a third party nor be used for any unauthorized purpose. Contravention will be prosecuted.

185

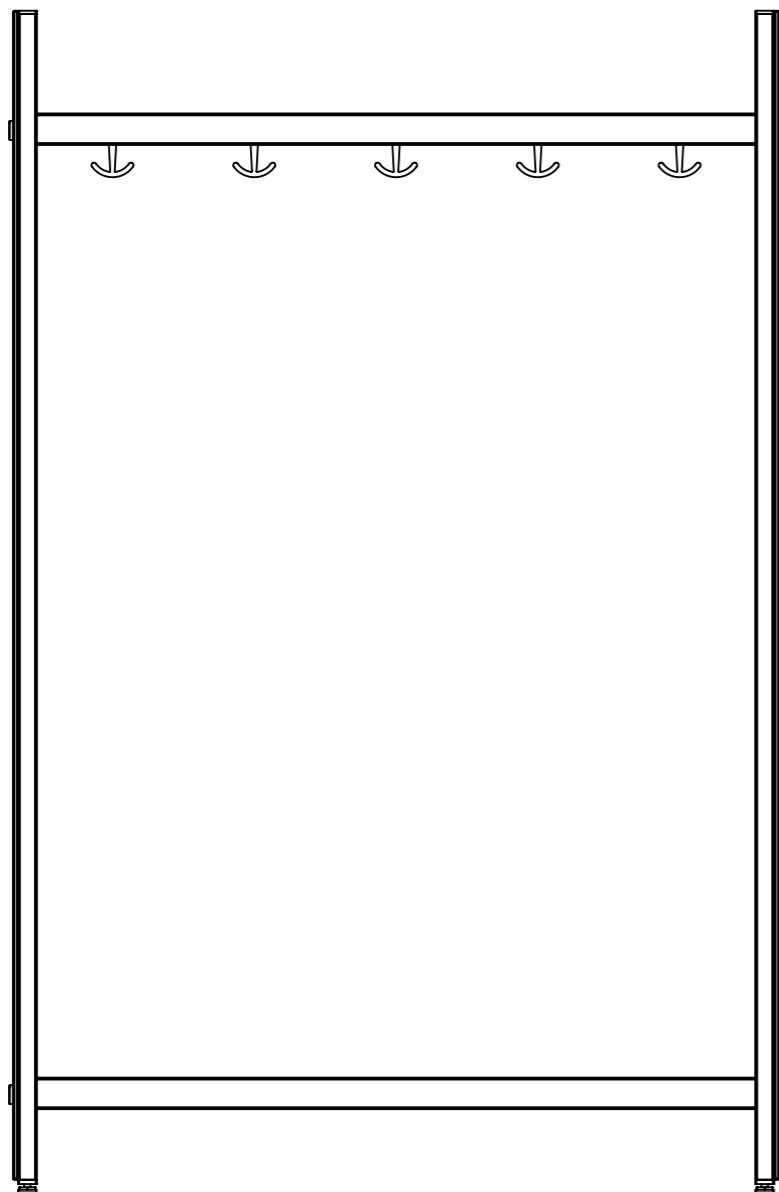

83/103/123

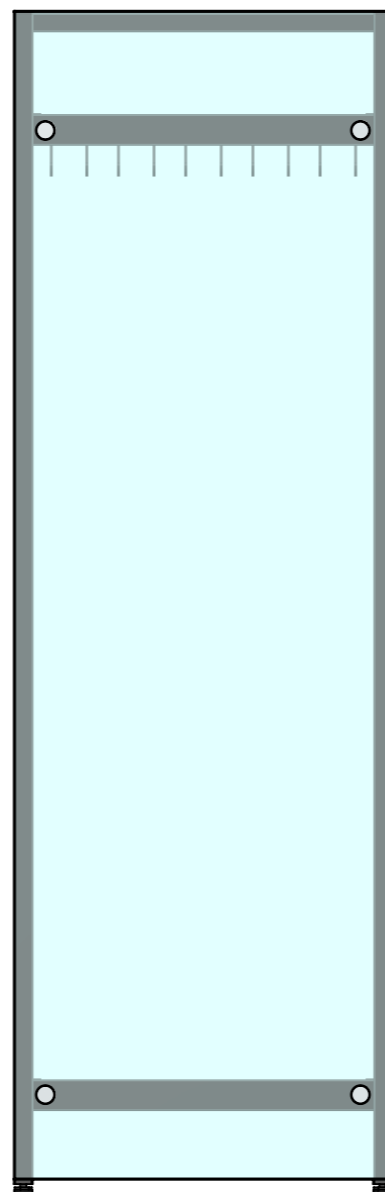

60

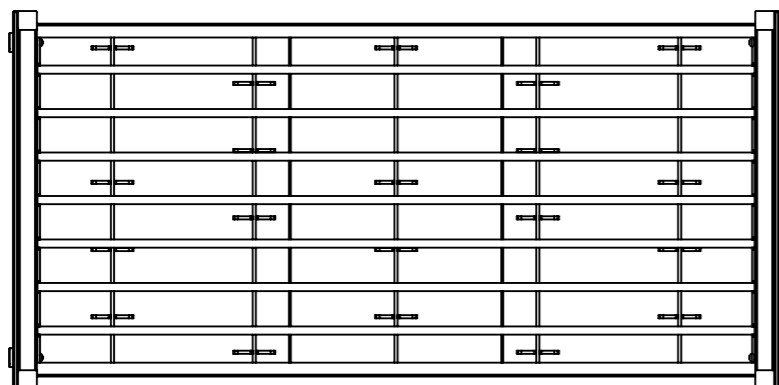
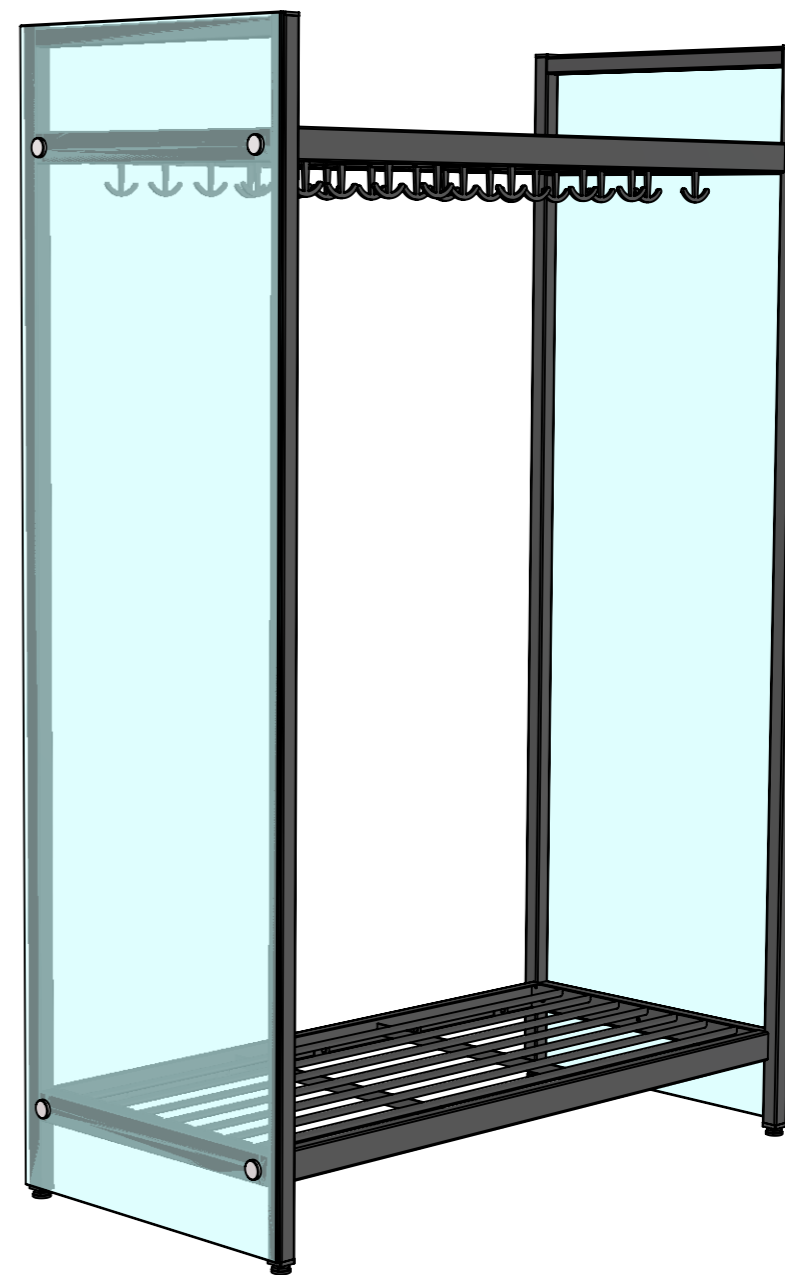

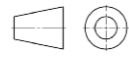
					Customer Mallitilat	
			Description Quadrat 1804 naulakko lasipäädyillä			
Designed By JT <i>i</i>			Date 24.11.2022		Document Number <b>A KLT9</b>	Size A3
Approved By			Mass 51.01 kg			Color
Dimensions (mm)			Scale 1:12		Sheet 1 / 1	

Revision	Description	Designer	Date
----------	-------------	----------	------

This document must not be copied without our written permission, and the contents thereof must not be imparted to a third party nor be used for any unauthorized purpose. Contravention will be prosecuted.

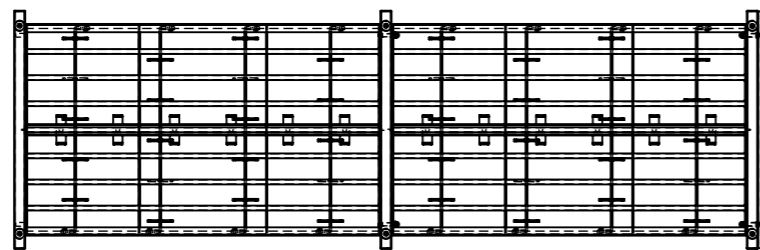
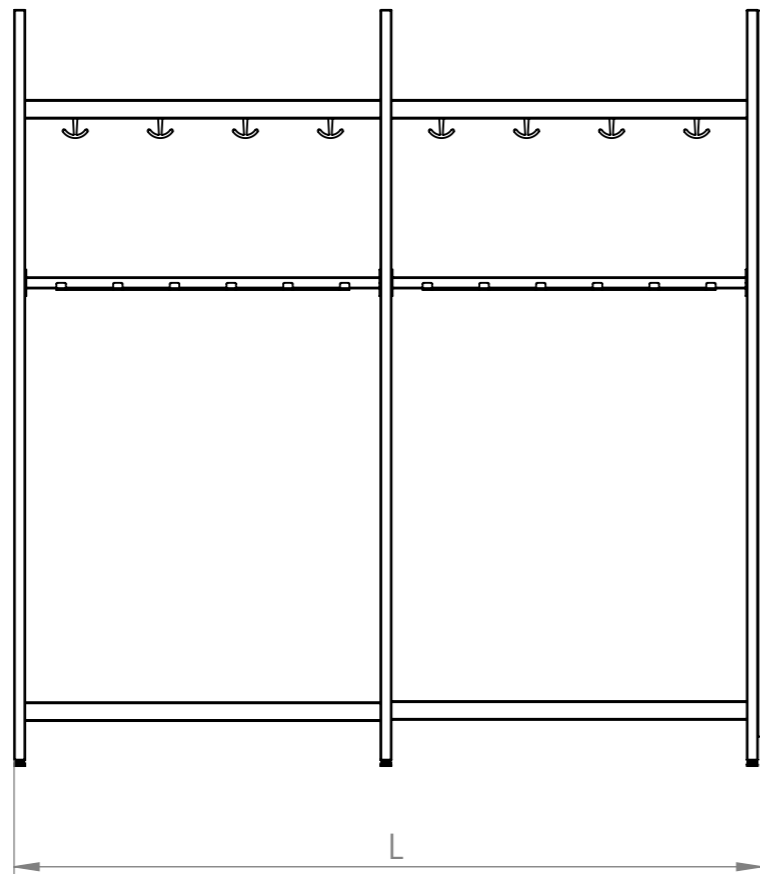
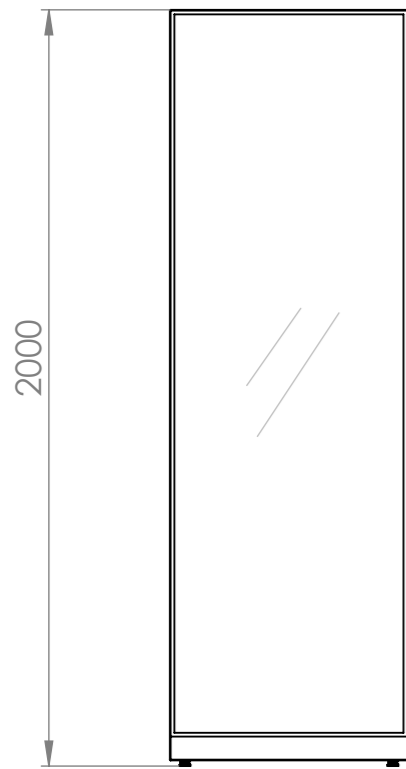

					Customer Mallilat	
			Description Massive 2004 narikkanaulakko			
Designed By 			Date 27.3.2023		Document Number <b>NP2</b>	Size <b>A3</b>
Approved By 			Material Mass 153.79 kg			Color 
Dimensions (mm)			Scale 1:20		Sheet 1 / 1	

Revision	Description	Designer	Date
----------	-------------	----------	------

This document must not be copied without our written permission, and the contents thereof must not be imparted to a third party nor be used for any unauthorized purpose. Contravention will be prosecuted.

35/45

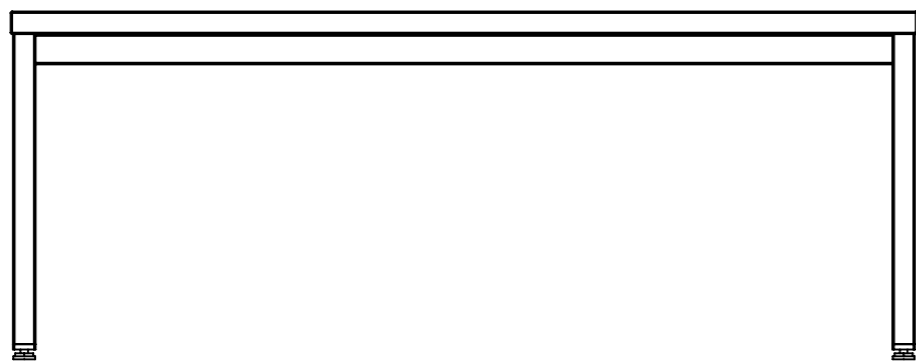

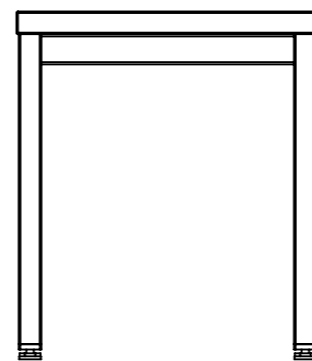

60/90/120

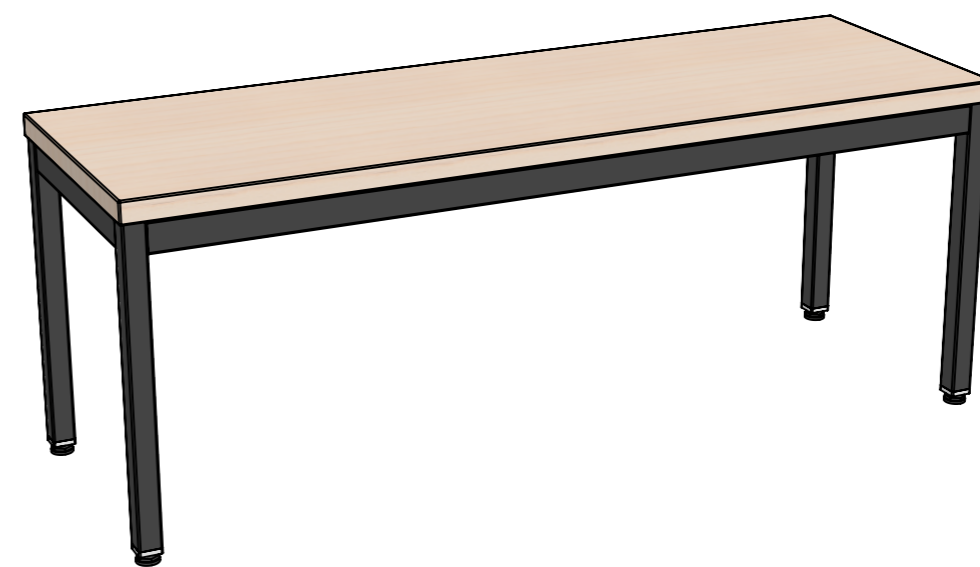

30/40





					Customer Mallilat										
			General Tolerance		Description Penkki 6900										
<table border="1"> <tr> <td>Designed By</td> <td>JTi</td> <td>Date</td> <td>24.11.2022</td> </tr> <tr> <td>Approved By</td> <td></td> <td></td> <td></td> </tr> </table>			Designed By	JTi	Date	24.11.2022	Approved By				Material		Document Number A PE1		Size A3
Designed By	JTi	Date	24.11.2022												
Approved By															
			Mass 21.62 kg		Color		Rev								
Revision			Description		Designer		Date	Scale 1:10	Sheet 1 / 1						

This document must not be copied without our written permission, and the contents thereof must not be imparted to a third party nor be used for any unauthorized purpose. Contravention will be prosecuted.

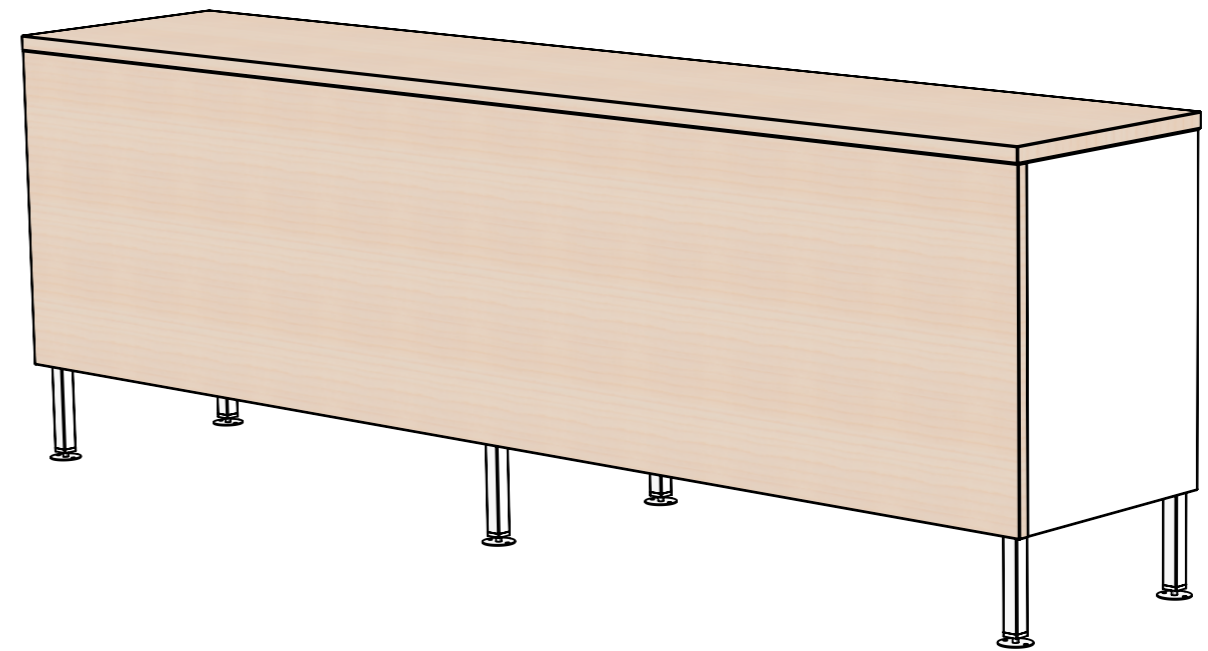
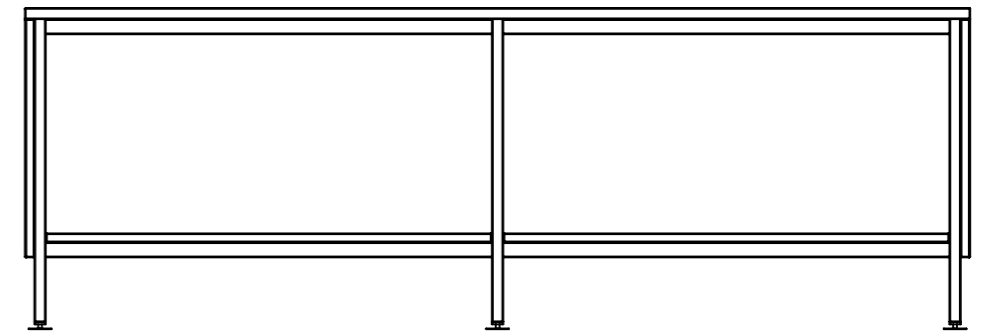
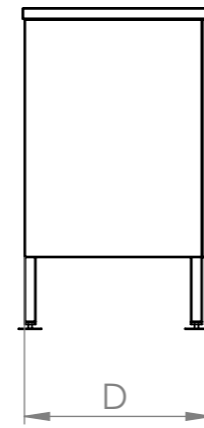
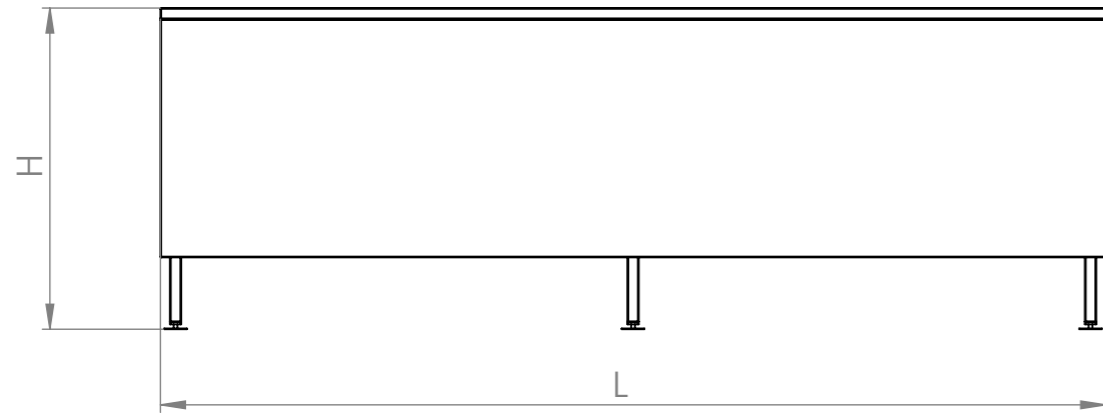



					Customer Mallilat	
			Description Palvelutiski			
Designed By 			Date 27.3.2023		Document Number <b>NP3</b>	Size <b>A3</b>
Approved By 			Mass 140.04 kg			Color 
Dimensions (mm)			Scale 1:20		Sheet 1 / 1	

Revision	Description	Designer	Date
----------	-------------	----------	------

This document must not be copied without our written permission, and the contents thereof must not be imparted to a third party nor be used for any unauthorized purpose. Contravention will be prosecuted.

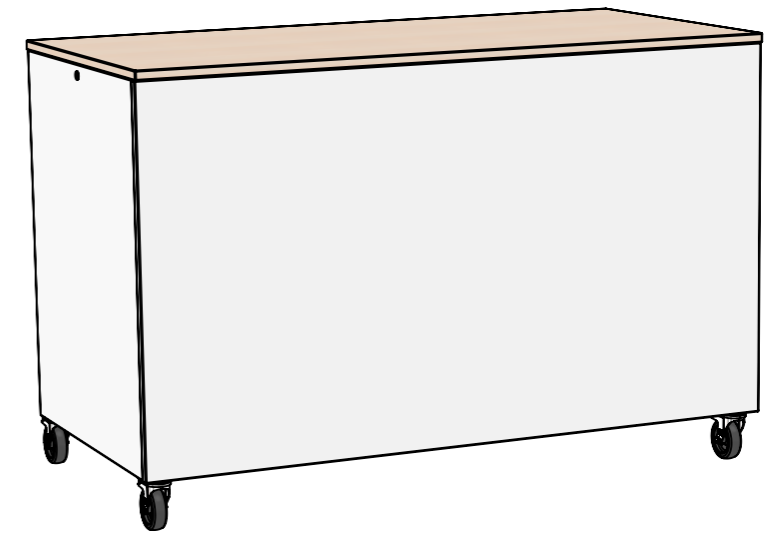
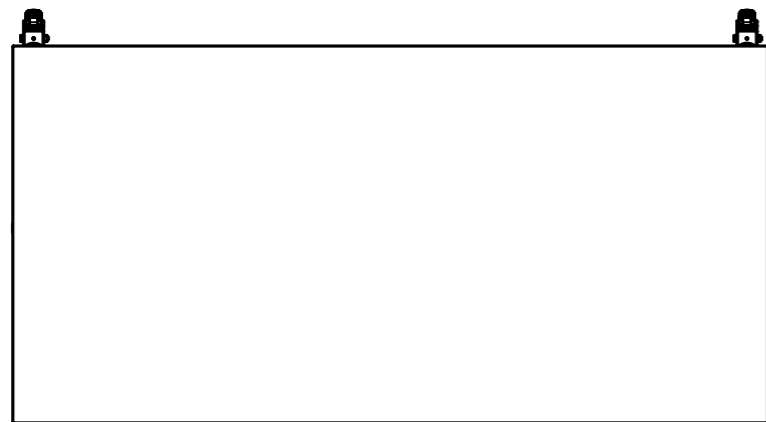
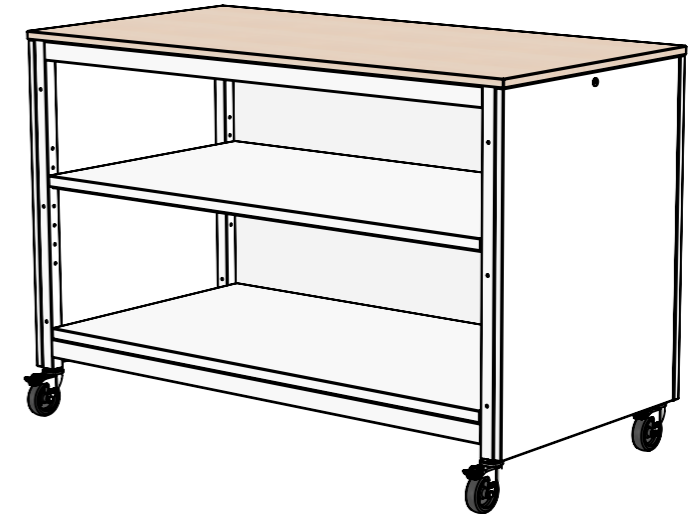
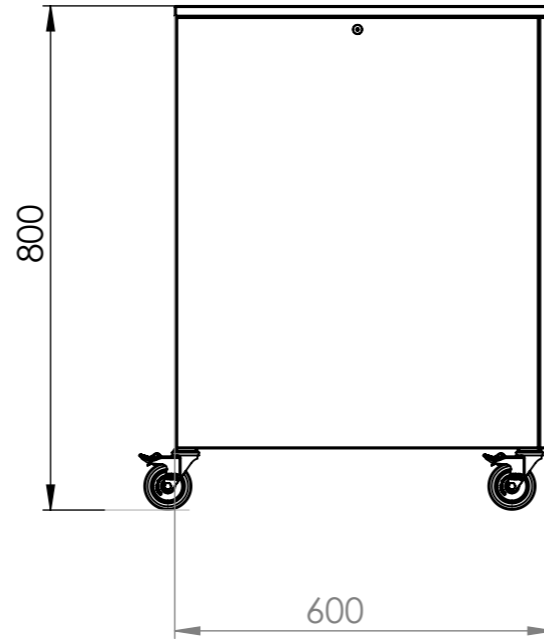



					Customer Mallilat		
			Description Palvelutiski pyörillä		Document Number NP4		
Designed By	Name	Date	Material	Dimensions (mm)	Color	Scale 1:12	Sheet 1 / 1
Approved By		27.3.2023	Mass 85.03 kg				
					Size A3	Rev	

Revision	Description	Designer	Date
----------	-------------	----------	------

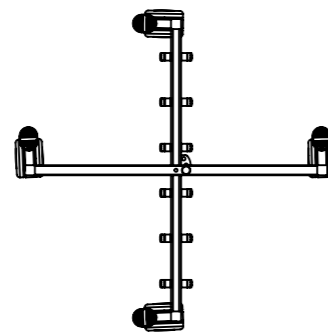
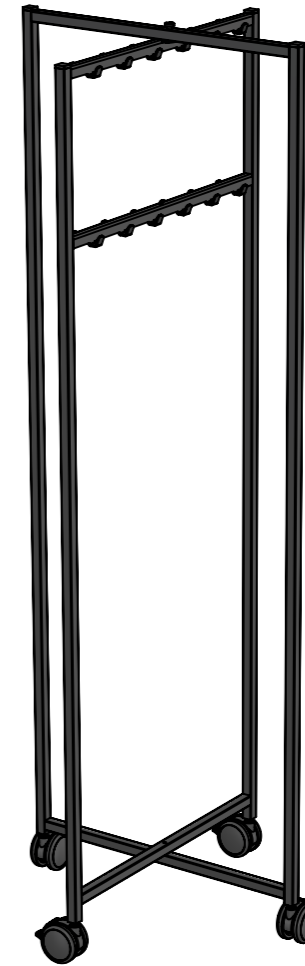
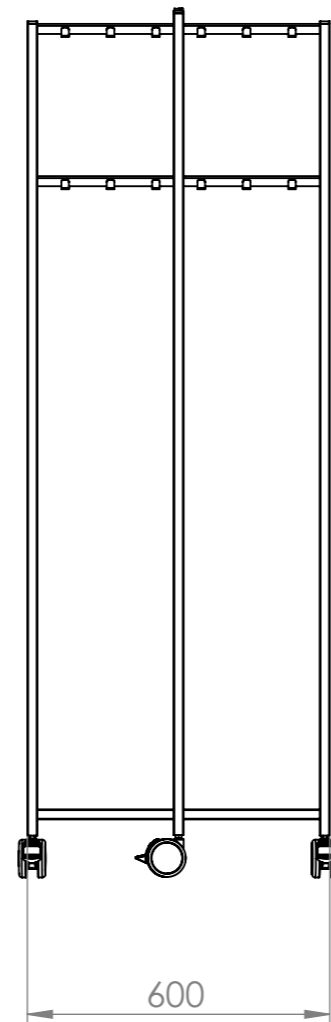
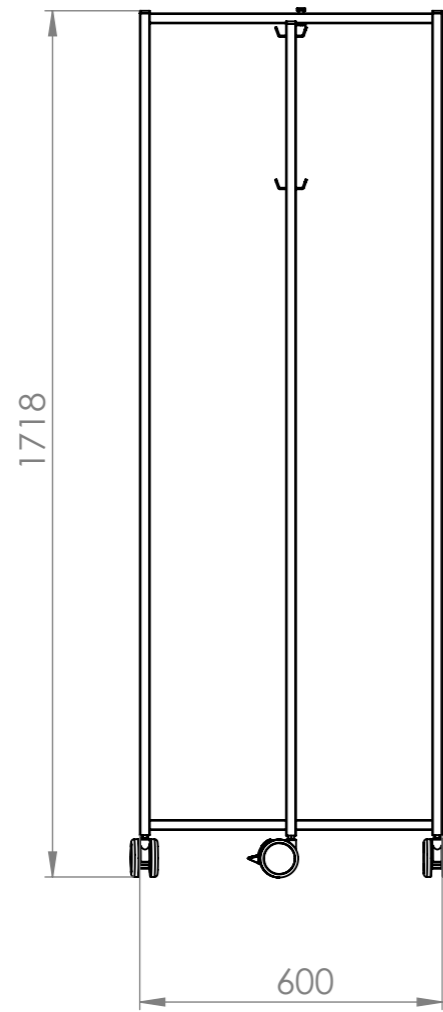
This document must not be copied without our written permission, and the contents thereof must not be imparted to a third party nor be used for any unauthorized purpose. Contravention will be prosecuted.





					Customer Mallitilat	
			General Tolerance		Description Fold naulakko pyörillä	
Designed By	Name	Date	Material	Document Number NP5		Size A3
Approved By			Mass 1.60 kg	Color		Rev
			Dimensions (mm)	Scale 1:15	Sheet 1 / 1	

Revision	Description	Designer	Date
----------	-------------	----------	------

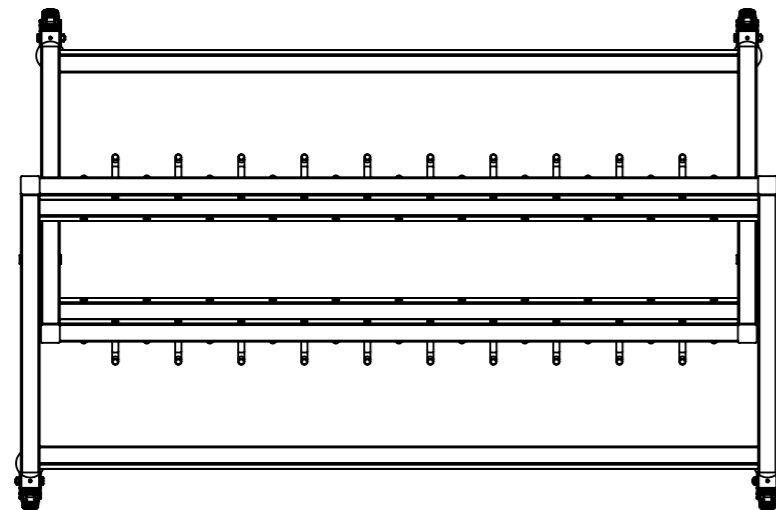
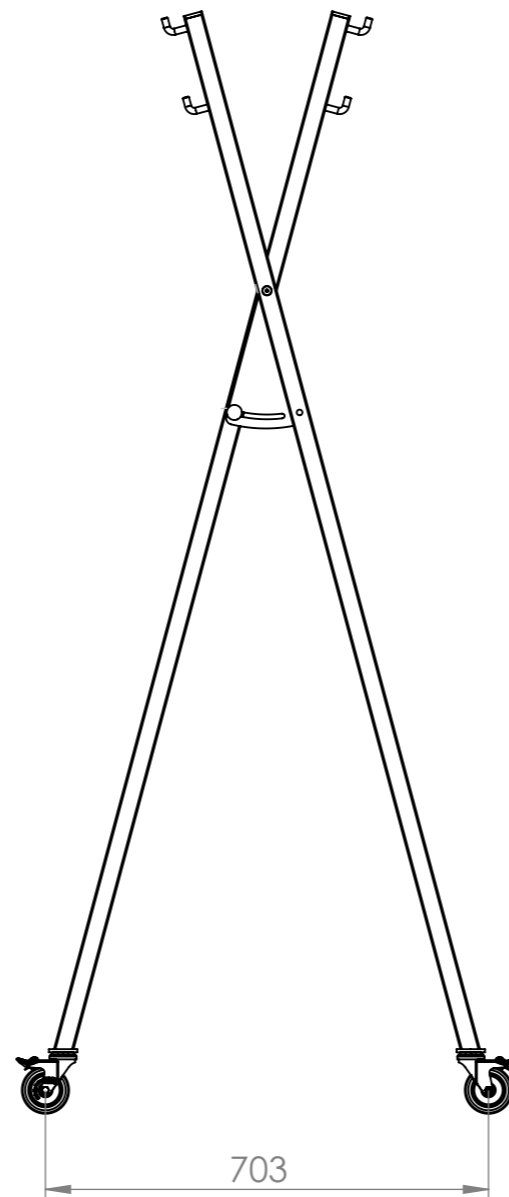
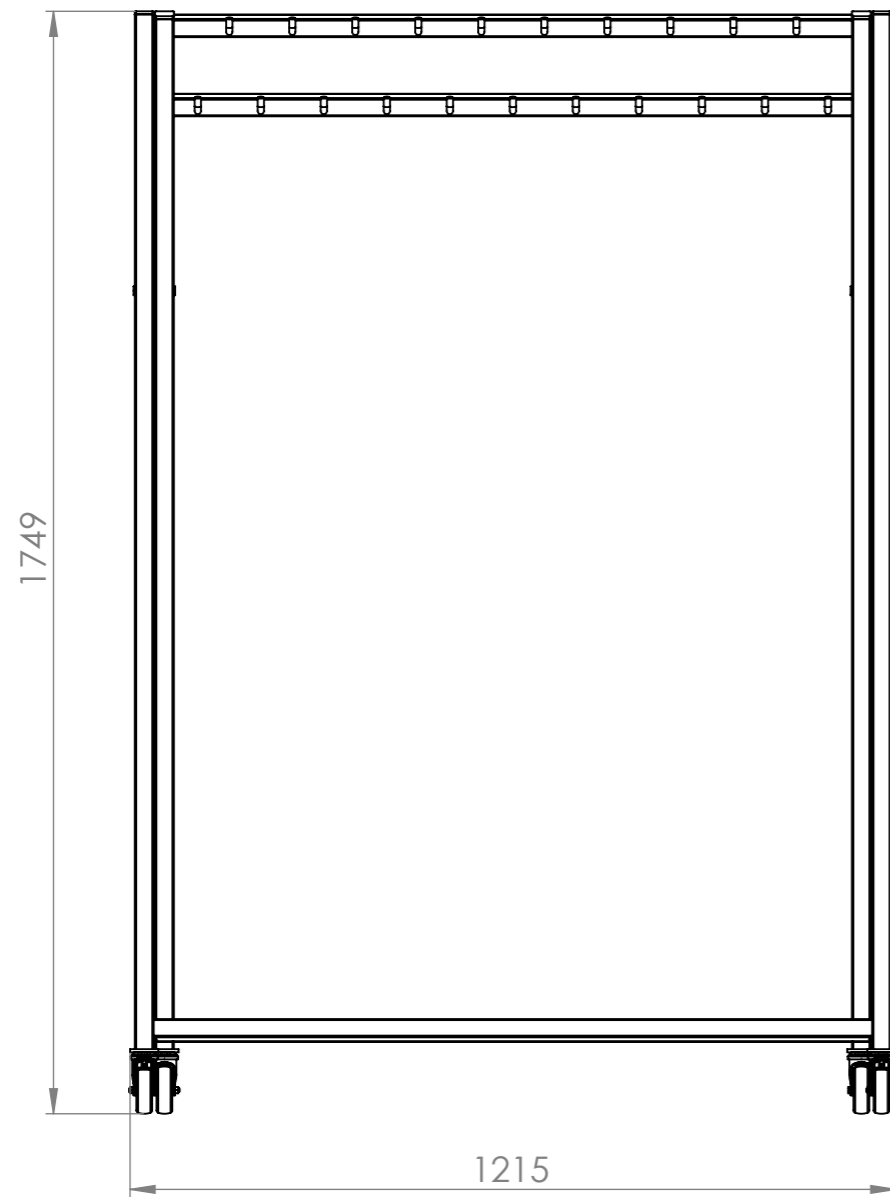
This document must not be copied without our written permission, and the contents thereof must not be imparted to a third party nor be used for any unauthorized purpose. Contravention will be prosecuted.



					Customer Cocoon	
			Description Cocoon naulakko 122x70x175			
Designed By 			Date 27.3.2023		Document Number <b>NP6</b>	Size <b>A3</b>
Approved By 			Mass 7.44 kg			Color 
Dimensions (mm)			Scale 1:12		Sheet 1 / 1	

Revision	Description	Designer	Date
----------	-------------	----------	------

This document must not be copied without our written permission, and the contents thereof must not be imparted to a third party nor be used for any unauthorized purpose. Contravention will be prosecuted.

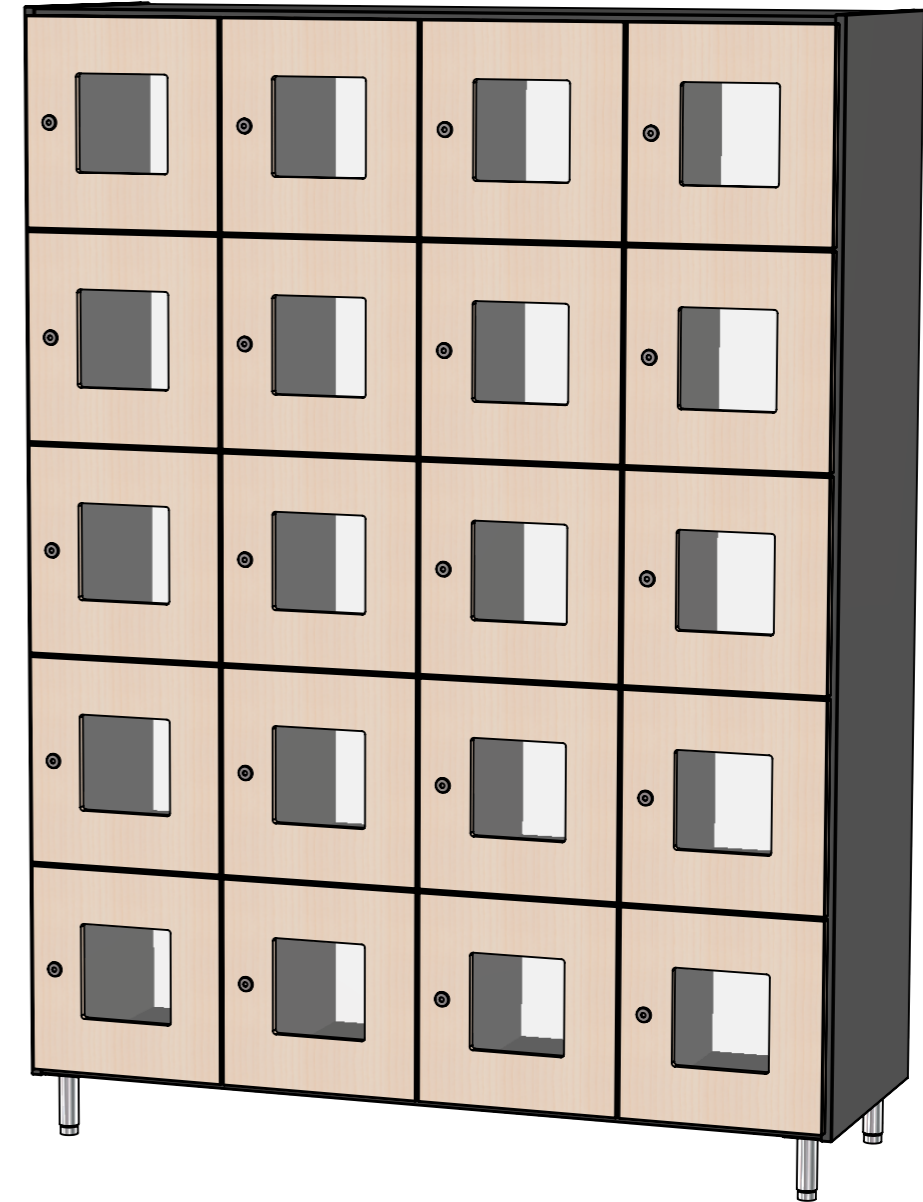
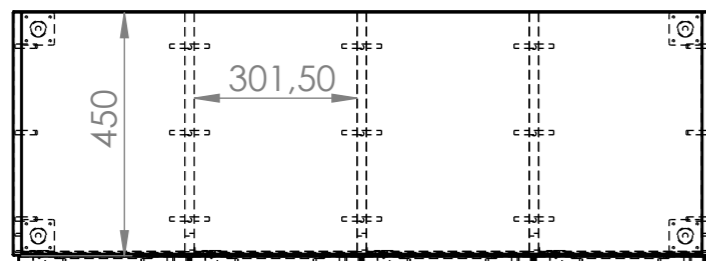
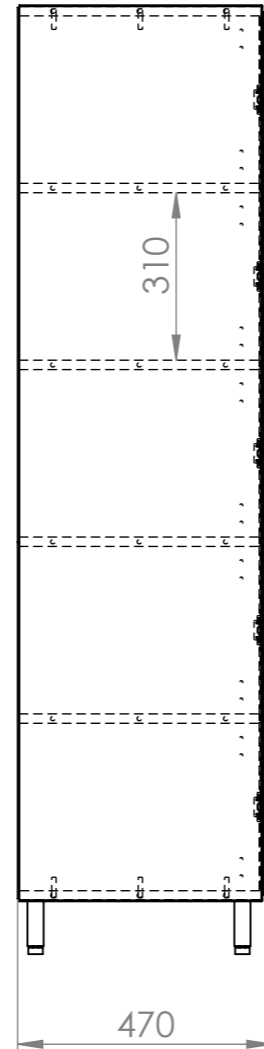
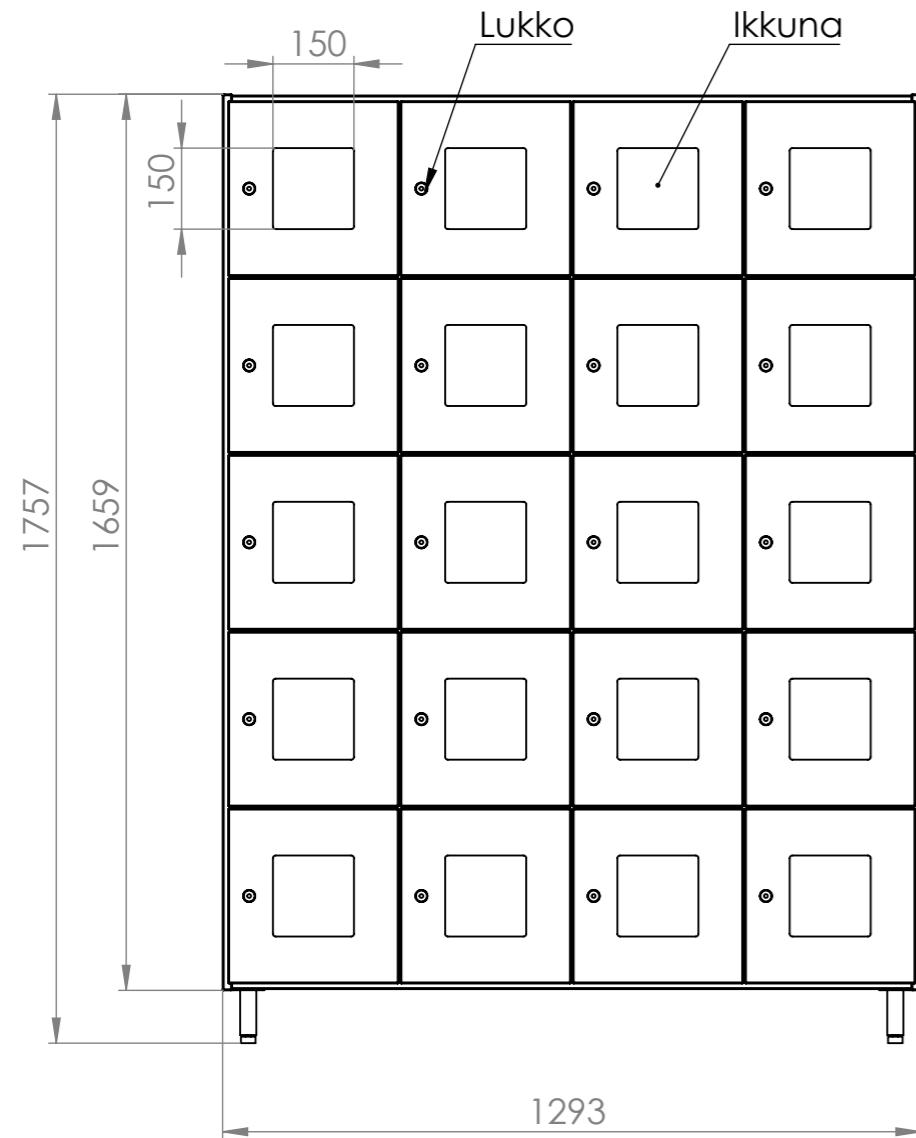

Lokerikko kiinnitettävä tukevasti seinään!

					Customer Mallitilat
			Description Lokerikko 4x5 130x47x176 neliöikkunoilla		
Designed By Approved By			Description 2 (104401)		Document Number <b>NP7</b>
Date 4.4.2023			Material Mass 155.97 kg		Size <b>A3</b>
Dimensions (mm)			Color		Rev
Scale 1:14			Sheet 1 / 1		

Revision	Description	Designer	Date
----------	-------------	----------	------

This document must not be copied without our written permission, and the contents thereof must not be imparted to a third party nor be used for any unauthorized purpose. Contravention will be prosecuted.